



DEVILBISS SKULL PUNCH



Size	Art No
21 CM – 8 ¼”	21-01-21

CONE SKULL PUNCH



Size	Art No
21 CM – 8 ¼”	21-02-21

CRUTCHFIELD SKULL TRACTION TONG



	Art No
PAEDIATRIC	21-03-01
ADULT	21-03-02

GARDNER WELLS SKULL TRACTION TONG



Art No
21-04-00

LEYLA (YASARGIL) BRAIN RETRACTOR SYSTEM COMPLETE SET



(WITH 2 FLEXIBLE ARMS,
2 FIXATION BASE,
2 SUPPORT FOR BRAIN SPATULAS,
1 BALL & SOCKET JOINT,
1 HOLDING ROD HEAD,
1 COUPLING HEAD)

Art No
21-05-00

AACHEN BRAIN SPATULA 20 CM – 8”



Size	Art No
7 MM X 8 MM	21-06-07
10 MM X 11 MM	21-06-10
13 MM X 14 MM	21-06-13
16 MM X 17 MM	21-06-16
19 MM X 20 MM	21-06-19
20 MM X 25 MM	21-06-20

CARINS (DAVIS) BRAIN SPATULA 20 CM – 8”



Size	Art No
6 MM	21-07-06
12 MM	21-07-12
18 MM	21-07-18
25 MM	21-07-25

HEIFETZ BRAIN SPATULA 15.5 CM – 6”



Size	Art No
8 MM	21-08-08
11 MM	21-08-11
14 MM	21-08-14
17 MM	21-08-17



HEIFETZ BRAIN SPATULA 20 CM – 8"



Size	Art No
8 MM	21-09-08
11 MM	21-09-11
14 MM	21-09-14
17 MM	21-09-17
20 MM	21-09-20

HUDSON BRACE DRILL SET



COMPLETE WITH
1 BRACE,
1 EXTENSION PIECE,
2 SPHERICAL BURRS
2 PERFORATORS,
2 CONICAL BURRS

Art No
21-10-00

SPHERICAL BURR



Size	Art No
11 MM	21-11-11
13 MM	21-11-13
16 MM	21-11-16
19 MM	21-11-19
22 MM	21-11-22
25 MM	21-11-25

PERFORATOR



Size	Art No
10 MM	21-12-10
12 MM	21-12-12
15 MM	21-12-15
18 MM	21-12-18
20 MM	21-12-20
24 MM	21-12-24

CONICAL BURR



Size	Art No
9 MM	21-13-09
11 MM	21-13-11
13 MM	21-13-13
16 MM	21-13-16

TREPINE



Size	Art No
35 MM	21-14-35
45 MM	21-14-45
50 MM	21-14-50

DE MARTEL (BAILEY) GIGLI SAW GUIDE



Size	Art No
33 CM – 13"	21-15-33

GIGLI SAW WIRE

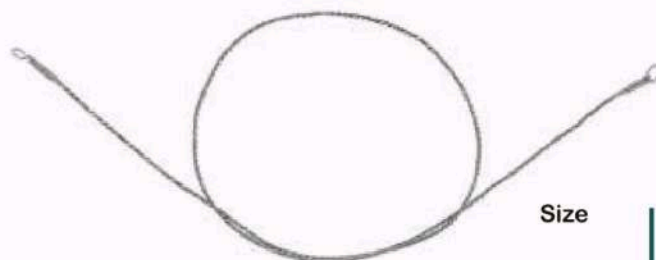

Size	Art No
30 CM – 12"	21-16-30
50 CM – 20"	21-16-50



GIGLI SAW HANDLES SET OF 2



Art No
21-17-20

YASARGIL GALEA HOOK



Size	Art No
31 CM – 12 1/8"	21-18-31
41 CM – 16"	21-18-41

RANEY CLIP APPLICATOR



Size	Art No
16 CM – 6 1/4"	21-19-16

MCKENZIE CLIP APPLICATOR



Size	Art No
15.5 CM – 6"	21-20-15
18 CM – 7"	21-20-18

OLIVERCONA-TOENNIS CLIP APPLICATOR



Size	Art No
14 CM – 5 1/2"	21-21-14
20 CM – 8"	21-21-20

DANDY NERVE RETRACTOR 20CM – 8"

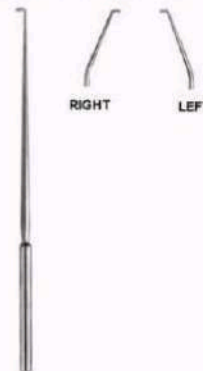

	Art No
STRAIGHT	21-22-01
RIGHT	21-22-02
LEFT	21-22-03

CUSHING NERVE RETRACTOR 19 CM – 7 1/2"

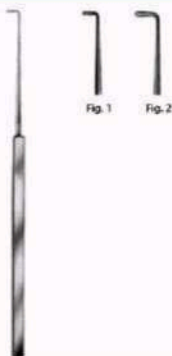

Size	Art No
FIG. 1 – 4 MM	21-23-04
FIG. 2 – 6 MM	21-23-06

HONE NERVE HOOK



Size	Art No
23 CM – 9"	21-24-23



ADSON NERVE HOOK 20 CM – 8”



	Art No
SHARP	21-25-01
BLUNT	21-25-02

SCOVILLE NERVE ROOT RETRACTOR 26 CM – 10 ¼”



	Art No
STRAIGHT	21-26-01
45 DEGREE	21-26-02
90 DEGREE	21-26-03

HESS NERVE ROOT RETRACTOR 18 CM - 7”



Size	Art No
3 MM	21-27-03
5 MM	21-27-05
7 MM	21-27-07

LOVE



Size	Art No
21 CM – 8 ¼”	21-28-21

CASPAR 24 CM – 9 ½”



Size	Art No
6 MM	21-29-06
8 MM	21-29-08
10 MM	21-29-10

CUSHING DECOMPRESSION HOOK



Size	Art No
20 CM – 8”	21-30-20

MEYERDING RETRACTOR 23 CM – 9”



Size	Art No
50 MM X 16 MM	21-31-01
75 MM X 25 MM	21-31-02
90MM X 50 MM	21-31-03

TAYLOR SPINAL RETRACTOR 18 CM – 7”

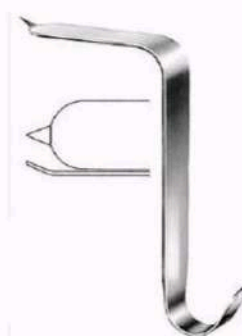

Size	Art No
75 MM X 30 MM	21-32-01
100 MM X 30 MM	21-32-02



HOEN DURA SEPARATOR 15.5 CM – 6”

CLOWARD VERTEBRAL SPREADER FOR LUMBAR



Size	Art No
45 DEGREE	21-33-01
90 DEGREE	21-33-02



Art No
21-34-00

CLOWARD VERTEBRAL SPREADER FOR CERVICAL

INGE (BABY) LAMINA SPREADER

INGE LAMINA SPREADER



Art No
21-35-00



Size
16 CM – 6 1/4”

Art No
21-36-16



Size
27 CM – 10 3/4”

Art No
21-37-27

CASPAR CERVICAL RETRACTOR TRANSVERSAL PATTERN COMPLETE SET

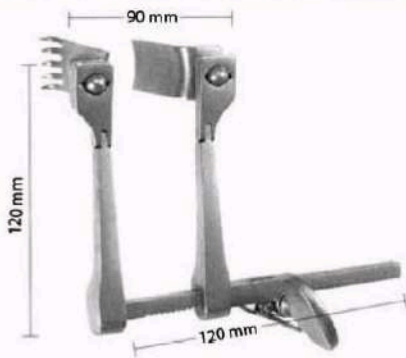

MEDIAL TOOTHED

- 40 x 23 mm
- 45 x 23 mm
- 50 x 23 mm
- 55 x 23 mm
- 60 x 23 mm



LATERAL SERRATED

- 40 x 23 mm
- 45 x 23 mm
- 50 x 23 mm
- 55 x 23 mm
- 60 x 23 mm



BLUNT

- 40 x 23 mm
- 45 x 23 mm
- 50 x 23 mm
- 55 x 23 mm
- 60 x 23 mm

RETRACTOR WITH 5 MEDIAL, 5 LATERAL & 5 BLUNT BLADES

Art No - 21-38-00

CASPAR CERVICAL COUNTER RETRACTOR LONGITUDINAL PATTERN (SPECULUM TYPE) COMPLETE SET

CASPAR CERVICAL COUNTER RETRACTOR LONGITUDINAL PATTERN COMPLETE SET



RETRACTOR WITH 10 BLUNT BLADES

Art No - 21-39-00



RETRACTOR WITH 10 BLUNT BLADES

Art No - 21-40-00



CASPAR VERTEBRAL COLOUMN RETRACTOR COMPLETE SET



(1 RETRACTOR FRAME, 1 KEY, 2 HOOKS, 8 TWO PRONGS BLADES
8 THREE PRONGS BLADES & 8 FOUR PRONG BLADES)

Art No - 21-41-00

CASPAR VERTEBRAL BODY DISTRACTOR COMPLETE SET

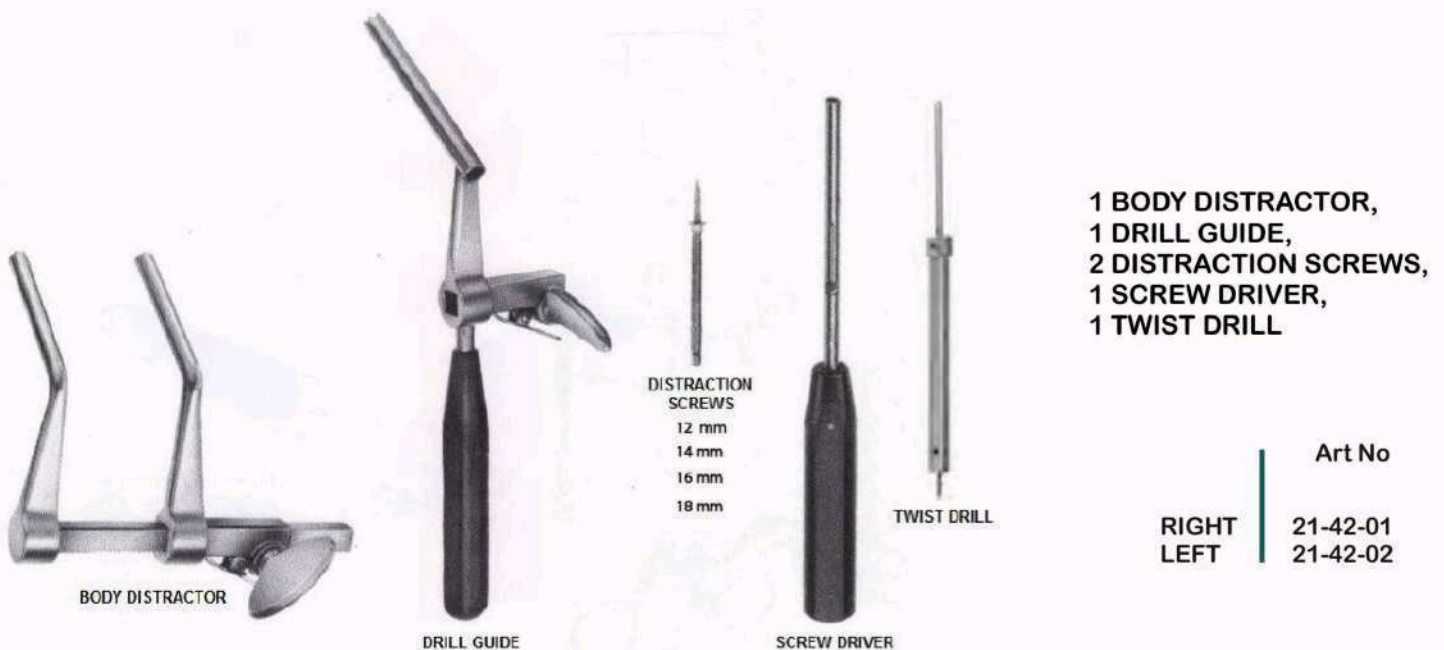



CASPAR MICRO LUMBAR DISCECTOMY RETRACTOR COMPLETE SET



COUNTER RETRACTOR



LATERAL BLADES

- 35 mm
- 40 mm
- 45 mm
- 50 mm
- 55 mm
- 60 mm
- 65 mm
- 75 mm
- 85 mm



PARASPINAL BLADES

- 35 mm
- 40 mm
- 45 mm
- 50 mm
- 55 mm
- 60 mm
- 65 mm



LUMBAR SPECULUM

- 40 mm
- 45 mm
- 50 mm
- 55 mm
- 60 mm
- 65 mm
- 75 mm
- 85 mm

1 COUNTER RETRACTOR,
9 LATERAL BLADES,
7 PARASPINAL BLADES,
2 LUMBAR SPECULUMS

Art No 21-43-00

CLOWARD RETRACTOR WITH HINGE 25 CM – 10" COMPLETE SET



TOOTHED BLADES

- 40 x 15/23 mm
- 45 x 15/23 mm
- 45 x 15/23 mm
- 55 x 15/23 mm
- 60 x 15/23 mm



BLUNT BLADES

- 40 x 15/23 mm
- 45 x 15/23 mm
- 50 x 15/23 mm
- 55 x 15/23 mm
- 60 x 15/23 mm

1 RETRACTOR ,
5 TOOTHED BLADES,
5 BLUNT BLADES

Art No 21-44-00



CLOWARD RETRACTOR WITHOUT HINGE 17 CM – 6 1/2" COMPLETE SET



1 RETRACTOR ,
5 TOOTHED BLADES,
5 BLUNT BLADES

Art No 21-45-00

SCOVILLE HAMILAMINECTOMY RETRACTOR WITHOUT HINGE COMPLETE SET



SCOVILLE
50 mm
75 mm



SCOVILLE
50 mm
75 mm



TAYLOR
44 x 38 mm



TAYLOR
67 x 47 mm



SCOVILLE
65 x 25 mm
90 x 25 mm
65 x 30 mm
65 x 50 mm



MEYERDING-SCOVILLE
65 x 25 mm
75 x 25 mm
90 x 50 mm



TAYLOR
75 x 32 mm
100 x 42 mm



(1 RETRACTOR FRAME, 2 SCOVILLE BLADES W/O CROSS BAR, 2 SCOVILLE BLADES WITH CROSS BAR, 1 TAYLOR THREE PRONGS BLADE, 1 TAYLOR FOUR PRONGS BLADE, 4 SCOVILLE TOOTHED BLADES, 3 MEYERDING-SCOVILLE BLADES, 2 TAYLOR BLADES)

Art No 21-46-00



SCOVILLE-HAVERFIELD HAMILAMINECTOMY RETRACTOR WITH HINGE COMPLETE SET



- 1 RETRACTOR FRAME,
- 2 SCOVILLE BLADES W/O CROSS BAR,
- 2 SCOVILLE BLADES WITH CROSS BAR,
- 1 TAYLOR THREE PRONGS BLADE,
- 1 TAYLOR FOUR PRONGS BLADE,
- 4 SCOVILLE TOOTHED BLADES,
- 3 MEYERDING-SCOVILLE BLADES,
- 2 TAYLOR BLADES)

Art No 21-47-00

DR. RAMANI MICRODISCECTOMY RETRACTOR WITHOUT HINGE COMPLETE SET

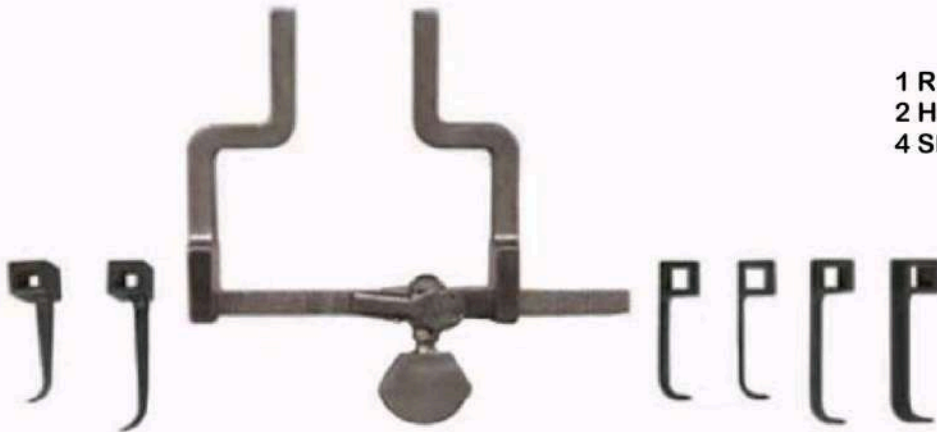

- 1 RETRACTOR,
- 2 HOOK BLADES,
- 4 SERRATED BLADES

Art No 21-48-00

DR. RAMANI MICRODISCECTOMY RETRACTOR WITH HINGE COMPLETE SET



- 1 RETRACTOR,
- 2 HOOK BLADES,
- 4 SERRATED BLADES

Art No 21-49-00



CONE VENTRICULAR CANNULA 9 CM – 3 1/2"



	Art No
12 G	21-51-12
14 G	21-51-14
16 G	21-51-16

SCOVILLE BRAIN SPATULA FORCEP 22 CM – 8 3/4"



Size	Art No
10 MM	21-52-10
13 MM	21-52-13

**YASARGIL SCISSOR BAYONET SHAPE
TUNGSTEN CARBIDE BLADES**



	STRAIGHT	CURVED
Size	Art No	Art No
20 CM – 8"	TC07-44-20	TC07-45-20
23 CM – 9"	TC07-44-23	TC07-45-23

**YASARGIL NEEDLE HOLDER BAYONET SHAPE
TUNGSTEN CARBIDE TIP**



	STRAIGHT	CURVED
Size	Art No	Art No
20 CM – 8"	TC03-13-20	TC03-14-20
23 CM – 9"	TC03-13-23	TC03-14-23

YASARGIL CURETTE TOOTHED 22 CM – 8 3/4"



Size	Art No
3 MM	06-33-22
5 MM	06-34-22

YASARGIL FLAT SERRATED 22 CM – 8 3/4"



Size	Art No
3 MM	06-35-22
5 MM	06-36-22

YASARGIL SPOON SHAPED 22 CM – 8 3/4"



Size	Art No
3 MM	06-37-22
5 MM	06-38-22

DENNIS MICRO RING TIP DIAMOND DUSTED JAWS



	1 MM	2 MM
Size	Art No	Art No
18 CM – 7"	DD06-39-18	DD06-40-18
20 CM – 8"	DD06-39-20	DD06-40-20



MICRO SUTURE TYING 15.5 CM – 6”



	Art No
STRAIGHT	03-27-15
CURVED	03-28-15

AUSTIN SUTURE TYING



Size	Art No
18 CM – 7”	03-29-18

YASARGIL MICRO FORCEP



Size	Art No
22 CM – 8 3/4”	21-53-22
24 CM – 9 1/2”	21-53-24

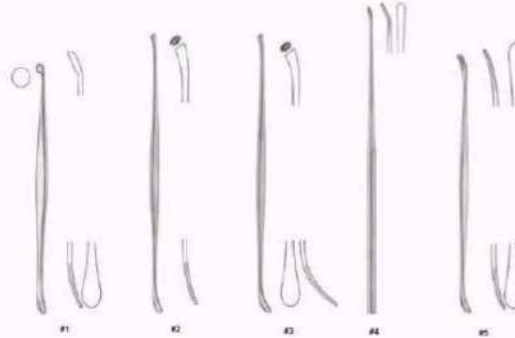

PENFIELD DISSECTOR

	Size	Art No
FIG #1	18 CM – 7”	21-54-01
FIG #2	20 CM – 8”	21-54-02
FIG #3	20 CM – 8”	21-54-03
FIG #4	20 CM – 8”	21-54-04
FIG #5	29 CM – 11 1/2”	21-54-05

JACOBSON BUTTONED PROBE 18.5 CM – 7 1/4”



	Art No
FIG #1	21-55-01
FIG #2	21-55-02

BIEMER VESSEL SPREADER



Size	Art No
16 CM – 6 1/4”	21-56-16

VESSEL DIALATOR 12.5 CM – 5”



Size	Art No
0.5 MM	21-57-05
1 MM	21-57-10
1.5 MM	21-57-15

YASARGIL ARACHNOID KNIVES 18.5 CM – 7 1/4”



	Art No
UPWARD	21-58-01
DOWNWARD	21-58-02



KOOS VESSEL KNIVES 18.5 CM – 7 1/4"



	Art No
FIG #1	21-59-01
FIG #2	21-59-02
FIG #3	21-59-03
FIG #4	21-59-04
FIG #5	21-59-05
FIG #6	21-59-06

SAMII TUMOR KNIVES 23 CM – 9"



Size	Art No
1 MM	21-60-10
1.5 MM	21-60-15
2 MM	21-60-20
2.5 MM	21-60-25
3 MM	21-60-30
3.5 MM	21-60-35
4 MM	21-60-40
4.5 MM	21-60-45

SAMII TUMOR KNIVES 23 CM – 9"



Size	Art No
1.5 MM	21-61-15
3 MM	21-61-30
4.5 MM	21-61-45
6 MM	21-61-60

SAMII LANCET KNIVES 23 CM – 9"



Size	Art No
1.8 MM	21-62-18
2.5 MM	21-62-25

YASARGIL TUMOR FORKS 20 CM – 8"



Size	Art No
5 MM	21-63-05
8 MM	21-63-08

DURA HOOK



	SHARP	BLUNT
Size	Art No	Art No
18.5 CM – 7 1/4"	21-64-01	21-64-02
23 CM – 9"	21-65-01	21-65-02

YASARGIL GUIDE & LIGATURE CARRIER 18.5 CM – 7 1/4"



Size	Art No
FIG. #1	21-66-01
FIG. #2	21-66-02
FIG. #3	21-66-03
FIG. #4	21-66-04

KRAYENBUHL NERVE AND VESSEL HOOK 18.5 CM – 7 1/4"



Size	Art No
3 MM (BALL POINT)	21-67-30
3.5 MM (BALL POINT)	21-67-35
2 MM	21-67-20
2.5 MM	21-67-25



YASARGIL RASPATORY (BAYONET) 18.5 CM – 7 ¼”

YASARGIL RASPATORY PLATE SHAPED 18.5 CM – 7 ¼”



	Art No
FIG. #1	21-68-01
FIG. #2	21-68-02
FIG. #3	21-68-03



Size	Art No
2 MM	21-69-20
3 MM	21-69-30

YASARGIL RASPATORY 18.5 CM – 7 ¼”

CASPAR DISSECTOR 20 CM – 8”



Size	Art No
FIG #1 (4MM)	21-70-01
FIG #2 (1MM)	21-70-02
FIG #3 (3MM)	21-70-03
FIG #4 (2MM)	21-70-04



Size	Art No
1 MM	21-71-10

CASPAR DISSECTOR (BAYONET) 21 CM – 8 ¼”

CASPAR DISSECTOR 23 CM – 9”

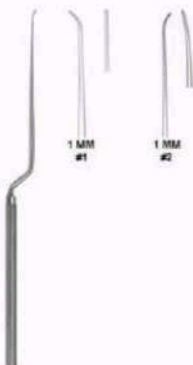

	Art No
FIG. #1	21-72-01
FIG. #2	21-72-02



	Art No
FIG. #1	21-73-01
FIG. #2 (BAYONET)	21-73-02
FIG. #3 (BAYONET)	21-73-03



RHOTON 19 CM – 7 1/2"

round dissectors

elevators



1 mm
#1



2 mm
#2



5 mm
#3



1.2 mm
#4



2.8 mm
#5

spatula dissectors

oval curettes



1 mm
#6



1.5 mm
#7



2 mm
#8



#9



1x2 mm
#10

45°

Hooks

Needle

probes



90°
2 mm
#11

semi sharp



90°
2 mm
#12

blunt



45°
3 mm
#13

semi sharp



#14



90°
#15

Art No

- ROUND DISSECTOR (1MM)
- ROUND DISSECTOR (2MM)
- ROUND DISSECTOR (5MM)
- ELEVATORS (1.2MM)
- ELEVATORS (2.8MM)
- SPATULA DISSECTOR (1 MM)
- SPATULA DISSECTOR (1.5 MM)
- SPATULA DISSECTOR (2 MM)
- OVAL CURETTE (STRAIGHT)
- OVAL CURETTE (45 DEGREE)
- HOOKS (SEMI SHARP)
- HOOKS (BLUNT)
- HOOKS (SEMI SHARP)
- NEEDLE
- PROBE

- FIG. #1
- FIG. #2
- FIG. #3
- FIG. #4
- FIG. #5
- FIG. #6
- FIG. #7
- FIG. #8
- FIG. #9
- FIG. #10
- FIG. #11
- FIG. #12
- FIG. #13
- FIG. #14
- FIG. #15

- 21-74-01
- 21-74-02
- 21-74-03
- 21-74-04
- 21-74-05
- 21-74-06
- 21-74-07
- 21-74-08
- 21-74-09
- 21-74-10
- 21-74-11
- 21-74-12
- 21-74-13
- 21-74-14
- 21-74-15



RAY PITUITARY CURETTE 19 CM - 7 1/2"

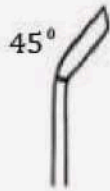

45°
3 mm
#1

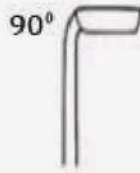

90°
3 mm
#2



45°
3 mm
#3

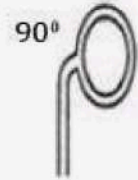

90°
3 mm
#4

4 mm
#5

4 mm
#6

4 mm
#7

4 mm
#8

5 mm
#9

5 mm
#10

5 mm
#11

5 mm
#12

Size

Art No

3 MM
3 MM
3 MM
3 MM
4 MM
4 MM
4 MM
4 MM
5 MM
5 MM
5 MM
5 MM

FIG. #1
FIG. #2
FIG. #3
FIG. #4
FIG. #5
FIG. #6
FIG. #7
FIG. #8
FIG. #9
FIG. #10
FIG. #11
FIG. #12

21-75-01
21-75-02
21-75-03
21-75-04
21-75-05
21-75-06
21-75-07
21-75-08
21-75-09
21-75-10
21-75-11
21-75-12



CONE RING CURETTE 23 CM – 9”



Size	Art No
4 MM	21-76-04
7 MM	21-76-07
9 MM	21-76-09

CONE RING CURETTE 23 CM – 9”



Size	Art No
4 MM	21-77-04
7 MM	21-77-07
9 MM	21-77-09

HARDY PITUITARY CURETTE 26 CM – 10 ¼”

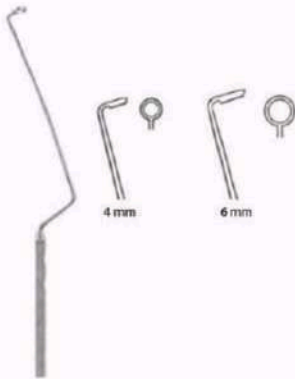

Size	Art No
4 MM	21-78-04
6 MM	21-78-06

NICOLA PITUITARY CURETTE 22 CM – 8 ¾” 6.5 MM

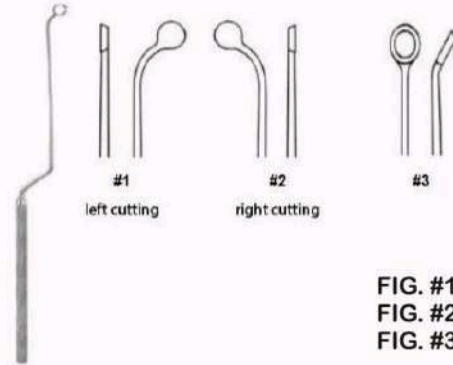
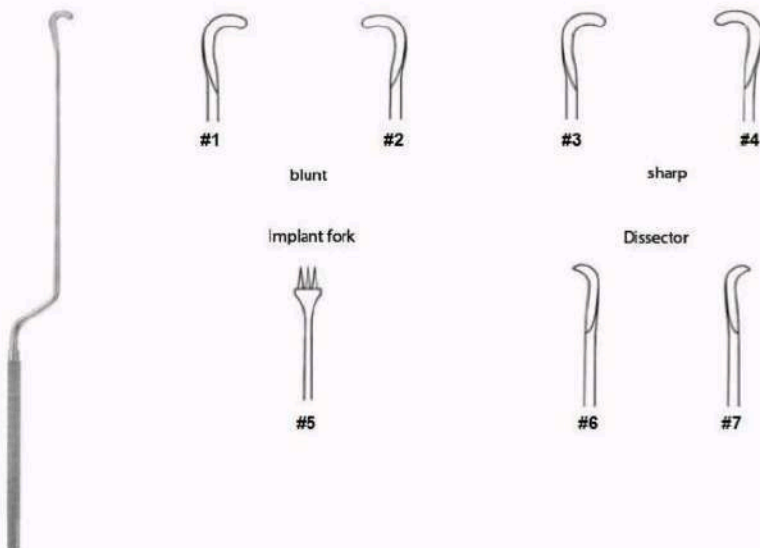

FIG. #	Art No
FIG. #1	21-79-01
FIG. #2	21-79-02
FIG. #3	21-79-03

HARDY 24 CM – 9 ½”

Enucleators



	Art No
ENUCLEATORS (BLUNT)	FIG. #1 21-80-01
ENUCLEATORS (BLUNT)	FIG. #2 21-80-02
ENUCLEATORS (SHARP)	FIG. #3 21-80-03
ENUCLEATORS (SHARP)	FIG. #4 21-80-04
IMPLANT FORK	FIG. #5 21-80-05
DISSECTOR	FIG. #6 21-80-06
DISSECTOR	FIG. #7 21-80-07



LANDOLT 26 CM – 10 3/4"

malleable enucleator

malleable curette



#1
blunt



#2
blunt

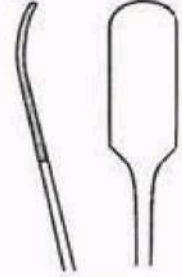

#3

malleable spoon

malleable hook

fork spatula

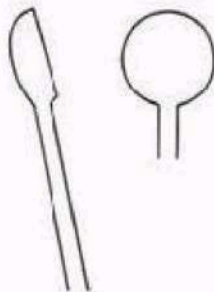

#4



#5

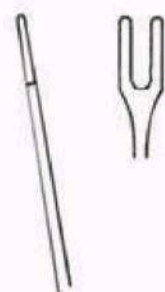

#6

ENUCLEATOR (BLUNT)
ENUCLEATOR (BLUNT)
CURETTE
SPOON
HOOK
FORK SPATULA

FIG. #1
FIG. #2
FIG. #3
FIG. #4
FIG. #5
FIG. #6

Art No

21-81-01
21-81-02
21-81-03
21-81-04
21-81-05
21-81-06



LANDOLT-REULEN 26 CM – 10 3/4"



1.7 mm



#1

Landolt-Reulen
Blunt hook

2.0 mm



#2

Landolt-Reulen
Dissector

2.2 mm



#3

Landolt-Reulen
Raspatory

2.5 mm



#4

Landolt-Reulen
Curette

2.5 mm



#5

Fahibusch
Spoon, malleable

2.5 mm



#6

Fahibusch
Curette, malleable

3.2 mm



#7

Landolt-Reulen
Raspatory

BLUNT HOOK (1.7 MM)
DISSECTOR (2.0 MM)
RASPATORY (2.2 MM)
CURETTE (2.5 MM)
SPOON (2.5 MM)
CURETTE (2.5 MM)
RASPATORY (3.2 MM)

FIG. #1
FIG. #2
FIG. #3
FIG. #4
FIG. #5
FIG. #6
FIG. #7

Art No

21-82-01
21-82-02
21-82-03
21-82-04
21-82-05
21-82-06
21-82-07

HARDY TRANS-SPHENOIDAL SPECULUM (BLACK FINISH)

LANDOLT SPREADER FOR SPECULA



Size	Art No
70 MM	21-83-70
80 MM	21-83-80
90 MM	21-83-90



Size	Art No
21 CM – 8 1/2"	21-84-21